

KENWOOD

40MHz DUAL TRACE OSCILLOSCOPE

CS-4035

20MHz DUAL TRACE OSCILLOSCOPE

CS-4026

CS-4025

INSTRUCTION MANUAL

KENWOOD CORPORATION

SAFETY

Symbol in This Manual



This symbol indicates where applicable cautionary or other information is to be found.

Power Source

This equipment operates from a power source that does not apply more than 250 V rms between the supply conductors or between either supply conductor and ground. A protective ground connection by way of the grounding conductor in the power cord is essential for safe operation.

Grounding the Product

This equipment is grounded through the grounding conductor of the power cord. To avoid electrical shock, plug the power cord into a properly wired receptacle before connecting to the equipment input or output terminals.

Use the Proper Power Cord

Use only the power cord and connector specified for your product.

Use the Proper Fuse

To avoid fire hazard, use a fuse of the correct type.

Do not Operate in Explosive Atmospheres

To avoid explosion, do not operate this product in an explosive atmosphere.

Do not Remove Cover or Panel

To avoid personal injury, do not remove the cover or panel. Refer servicing to qualified personnel.

Voltage Conversion

If the power source is not applied to your product, contact your dealer. To avoid electrical shock, do not perform the voltage conversion.

CONTENTS

SAFETY	2
SAFETY AND EQUIPMENT PROTECTION PRECAUTION	4
FEATURES	6
PANEL EXPLANATION.....	7
FRONT PANEL.....	7
REAR PANEL.....	12
CHECKING AND ADJUSTMENTS PRIOR TO MEASUREMENT	13
OPERATING PROCEDURES	15
SINGLE TRACE OPERATION	15
Alternating Current Display	15
Composite Video Signal Display.....	16
DUAL TRACE OPERATION.....	16
Switching Vertical Operation Modes.....	16
Switching Trigger Source.....	16
External Trigger.....	16
Line Trigger.....	17
SWEEP MAGNIFIED OPERATION	17
X-Y OPERATION.....	17
APPLICATIONS.....	18
Measuring Voltage Between Two Points on a Waveform	18
Common-Mode Rejection	19
Measuring Direct Current (DC) Voltage.....	20
Measuring Signals with Low Frequency Components	21
Measuring Signals with High Frequency Components.....	21
Measuring Time Between Two Points.....	22
Measuring Frequencies	23
Measuring Pulse Rise and Fall Times.....	23
Measuring Phase Differences.....	24
Displaying Lissajous Patterns.....	25
FUSE REPLACEMENT, CHANGING VOLTAGE REQUIREMENTS	27
FUSE REPLACEMENT	27
CHANGING VOLTAGE REQUIREMENTS.....	27
SPECIFICATIONS.....	28
OPTIONAL EQUIPMENT.....	31
How to Attach the Accessory Bag.....	31

SAFETY AND EQUIPMENT PROTECTION PRECAUTIONS

Take note of the following when using this manual.

This manual covers 3 oscilloscope models –CS-4035, CS-4026 and CS-4025.

However, most explanation is made using CS-4025 as an example.

Although most of the content is common to all 3 models, take note that any portion which is not expressed within brackets ([]).

1. Check your line voltage before use. The oscilloscope voltage rating appears on the back of the set. If your line voltage is different from the oscilloscope's rating, there is a danger of malfunctioning. You should plug in the cord only after making sure that the two voltage ratings are the same.

The oscilloscope comes with either a direct power cord or a power cord receptacle. If the direct power cord plug does not match your building's wall outlet, or if the line voltages are not the same, consult with the store where you bought your oscilloscope or a nearby dealer who handles the KENWOODS oscilloscope.

2. The oscilloscope is equipped with internal components that are highly charged electrically. For your own protection, do not for any reason remove the set's casing.
3. Do not use the oscilloscope in the following locations.
 - In direct sunlight.
 - In extremely hot and/or humid areas.
 - In areas affected by high levels of mechanical vibration.
 - Around areas with strong lines of magnetic force or impulse voltage.







4. Make sure that the voltage applied to each input terminal does not exceed the maximum amounts specified.

 CH1, CH2 input terminals: 500 V_{P-P} or 250 V (DC + AC_{peak})

 EXT. TRIG, Z.AXIS input terminals: 100 V_{P-P} or 50 V (DC + AC_{peak}).

Moreover, do not under any circumstances apply voltage to the output terminals from external power sources.

5. In order to prevent the CRT's fluorescent screen from scorching, do not adjust the brightness higher than necessary and do not leave the spotting function on for long periods of time.
6. The set has been equipped with auxiliary supports, so that you can position it in either horizontal or diagonal positions. However, do not place any objects on top of the set or position it in areas where the ventilation holes in the casing are blocked in any way. Such blockage will cause the temperature of the internal components to increase, resulting in possible damage to the unit.
7. Do not use $\times 10$ MAG during X-Y operation. Wave pattern noise tends to occur when $\times 10$ MAG is used.
8. The probe has been manufactured with the same level of delicate precision as the oscilloscope itself. Be very careful when handling it.

Plug configuration	Power cord and plug type	Factory installed instrument fuse	Line cord plug fuse
	North American 120 volt/60 Hz Rated 15 amp (12 amp max; NEC)	0.8 A, 250 V Fast blow AGC/3AG	None
	Universal Europe 220 volt/50 Hz Rated 16 amp	0.5 A, 250 V T. lag 5 × 20 mm	None
	U.K. 240 volt/50 Hz Rated 13 amp	0.5 A, 250 V Fast blow 6 × 30 mm	0.5 A Type C
	Australian 240 volt/50 Hz Rated 10 amp	0.5 A, 250 V Fast blow 6 × 30 mm	None
	North American 240 volt/60 Hz Rated 15 amp (12 amp max; NEC)	0.5 A, 250 V Fast blow AGC/3AG	None
	Switzerland 240 volt/50 Hz Rated 10 amp	0.5 A, 250 V Fast blow AGC/3AG 6 × 30 mm	None

Power Input Voltage Configuration

FEATURES

High Sensitivity

Sensitivity as high as 1 mV/div.

Wide Bands

The frequency band is DC to 5 MHz (–3 dB) at 1, 2 mV/div and DC to 20 MHz [DC to 40 MHz for CS-4035] (–3 dB) from 5 mV/div.

Continuous Switching Attenuator

A rotary switch enables vertical axis sensitivity to be adjusted continuously from 1m V/div to 5 V/div.

High Speed Sweep

High speed sweeping is possible at a time base of 50 ns/div (during $\times 10$ MAG) [20 ns/div for CS-4035 and CS-4026].

High Accuracy

Accuracy within 3% for both vertical axis sensitivity and sweep time.

Large Aperture

The 150 mm rectangular CRT monitor features an internal graticule easy visual recognition of waveforms. The waveforms displayed in high brightness can be monitored with no parallax.

Acceleration voltage: 12 kV for CS-4035 and CS-4026
2 kV for CS-4025

Trace Rotation

The horizontal trace angle is easily corrected.

Automatic Free Run

The trace can be checked even when there are no trigger signals to be input.

Television Trigger

With a specially designed circuit, adjustment-free, stable synchronization for both frames and lines can be realized over the whole range from large to small amplitudes.

One Touch X-Y

Switching to X-Y operation at the touch of a lever switch.

Automatic Trigger Signal Selection

Trigger signals can be selected automatically according to the VERT MODE control setting by simply switching the SOURCE control to VERT.

CH1 OUTPUT

A channel 1 output terminal has been added for CH1 input signal monitoring.

High Stability, High Reliability

Hybrid integrated circuits have been employed in all the components, realizing high standards in terms of both stability and reliability.

Prevention of Trace Line Jump When Selecting Input Signal Coupling

Better operability has been achieved with an anti- trace line jump circuit that prevents sudden changes in the trace position when input signal coupling is switched from GND to AC position.

Scale Illumination

The scale illumination function makes it possible to take photographs of waveform data displayed on the CRT in a darkend room. [CS-4025 does not have this function]

PANEL EXPLANATION

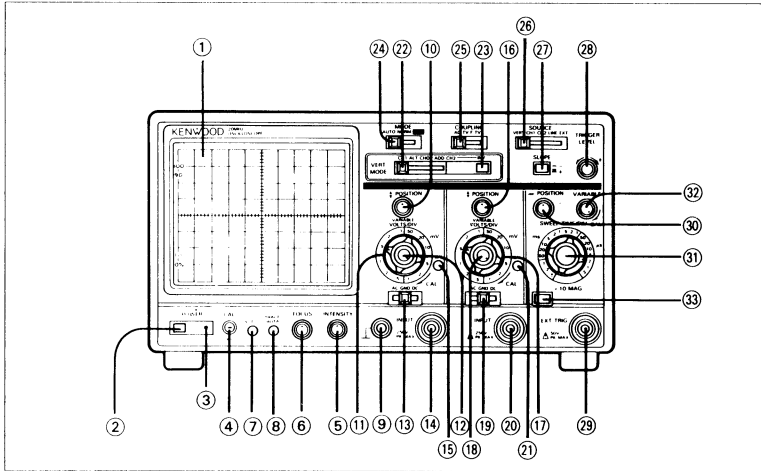

Figure 1. Front Panel

FRONT PANEL

① Cathode Ray Tube (CRT)

The effective display screen surface runs over an area of eight 1 cm divisions along the vertical axis and ten 1 cm divisions along the horizontal axis. With an inner graticule etched right onto the tube face, the chance of measurement errors due to parallax occurring between the trace and the graticule have been significantly reduced. There is also a % display for measuring rise time on the left edge of the graticule.

② POWER Switch (ON/ OFF)

A push-button type switch that turns the power source on and off. Pressing the switch turns the power on. Pressing it again turns the power off.

③ Pilot Lamp

Light ups when the power is turned on.

④ CAL Terminal

A voltage terminal for calibration. To be used for adjusting the probe. Capable of 1 volt peak to peak, positive polarity, square wave signals with twice the frequency of a commercial-use power source [approx. 1 kHz for CS-4035 and CS-4026] is enabled.

⑤ INTENSITY/PULL SCALE ILLUM Control

INTENSITY: For adjusting the brightness of the trace line.

PULL SCALE ILLUM: The brightness of the scale on the CRT can be adjusted by pulling this knob and turning it.

[CS-4025 does not have this function]

⑥ FOCUS Control

For adjusting the focus and attaining the clearest displays possible.

⑦ **ASTIG Control**

For adjusting the astigmatism of the trace and the spot. Use a screwdriver to adjust this control in conjunction with the FOCUS control for attaining the clearest displays possible. (Once the correct adjustment is made, no further re-adjustment is necessary during normal use.)

⑧ **TRACE ROTA Control**

For adjusting the slope of the horizontal trace line. The slope of the line will change due to such influences as the earth's magnetic force. Use a screwdriver to keep the trace line parallel with the horizontal axis graticule.

⑨ **⏏ GND Terminal**

This is the ground terminal to be used when setting up a common ground with other equipment.

⑩ **⬆ POSITION Control**

For adjusting the vertical position of the CH1 waveform displayed on the CRT screen. During X-Y operation it is used to adjust the position of Y-axis.

⑪ **VOLTS/DIV Control**

For setting the vertical axis sensitivity with the CH1 vertical axis attenuator. It can be set in steps of 1, 2 and 5. Setting the VARIABLE Control all the way to the right at CAL enables calibrated vertical sensitivity. During X-Y operation, it becomes the attenuator control for the Y-axis.

⑫ **VARIABLE Control**

For fine adjustment of CH1 vertical axis sensitivity. Allows continuous variable adjustment within the VOLTS/DIV range. When set to the right at CAL, the attenuator can be calibrated. During X-Y operation, it becomes the fine adjustment control for the Y axis.

⑬ **AC-GND-DC Switch**

For selecting the CH1 vertical axis input signal coupling mode.

AC: The input signal will be capacitively coupled, and all DC components will be eliminated. The low range – 3 dB attenuation point will be 10 Hz or less when using either a 1:1 probe or a coaxial cable, and 1 Hz or less when using a corrected 10:1 probe.

GND: Vertical amplifier input is grounded, and the ground potential can be checked. At an input resistance of $1M\Omega$ relative to the ground, the input signal is not grounded. In this mode, the anti-trace line jump circuit prevents the trace position from changing suddenly when switching from GND to AC.

DC: Provides direct coupling of the input signal, and measurement can be carried out with the direct current component intact.

During X-Y operation, this control becomes the Y-axis input switch.

⑭ **INPUT Jack**

The CH1 vertical axis input jack.

During X-Y operation, it becomes the Y-axis input jack.

⑮ **BAL Control**

For adjusting CH1 DC balance. Upon delivery of the oscilloscope, adjustments have already been made. However, discrepancies can occur due to various room temperatures. Using a screwdriver adjust this control so that the trace line does not move up and down when rotating the VOLTS/DIV control.

①⑥ **▲ POSITION Control**

For adjusting the vertical position of the CH2 waveform when displayed on the CRT screen.

Note: _____

When this control is rotated during X-Y operation, the trace may move a little in the horizontal direction. This is a normal occurrence and no cause for any adjustment.

①⑦ **VOLTS/DIV Control**

The vertical attenuator for CH2. It is operated in the same way as the CH1 VOLTS/DIV control.

During X-Y operation, it becomes the X-axis attenuator.

①⑧ **VARIABLE Control**

For fine adjustment of CH2 vertical axis sensitivity. It is operated in the same way as the CH1 VARIABLE control.

During X-Y operation, it is used for fine adjustment of X-axis sensitivity.

①⑨ **AC-GND-DC Switch**

For selecting the CH2 vertical axis input signal coupling mode. It is operated in the same way as the CH1 AC-GND-DC Switch.

During X-Y operation, it becomes the X-axis input switch.

②⑦ **INPUT Jack**

The CH2 vertical axis input jack.

During X-Y operation it becomes the X-axis input jack.

②① **BAL Control**

For adjusting CH2 DC balance. It is operated in the same way as the CH1 BAL control.

②② **VERT MODE Selector Switch**

For selecting the vertical axis operation mode.

CH1: For displaying the CH1 input signal on the CRT screen.

ALT: Switches between CH1 and CH2 input signals for each sweep and displays them on the CRT screen.

CHOP: For displaying CH1 and CH2 input signals one after the other on the CRT screen, irregardless of sweep and at an occurrence rate of about 250 kHz.

ADD: For displaying combined waveforms of CH1 and CH2 input signals on the CRT screen. However, when CH2 is set at INV, the difference between CH1 and CH2 will be displayed.

CH2: For displaying CH2 input signals on the CRT screen.

Alternate (ALT) and Chop (CHOP) Modes:

When using these modes during dual trace operation, the display will be divided up according to time.

In the chop mode, each channel will be subdivided according to time within each sweep. Normally, this kind of measurement is carried out with signals of either slower sweep rates from 1 ms/div or low repetition rates where flicker is quite noticeable.

In the alternate mode, each channel will be displayed one after the other as soon as one sweep has been made. Therefore, each channel display appears much clearer. Normally, a faster sweep is employed.

23 INV Switch

When the button is pushed all the way in, the polarity of the CH2 input signal display will be inverted.

24 MODE Selector Switch

For selecting trigger operation modes.

AUTO: Sweep is performed by a trigger signal.

However, in the absence of a trigger signal, free run will commence and a trace will appear. *beginner*

NORM: Sweep is performed by a trigger signal. In the absence of a suitable trigger signal, a trace will not appear.

X-Y: Ignores the VERT MODE setting and commences operation as an X-Y oscilloscope with CH1 as the Y-axis and CH2 as the X-axis.

25 COUPLING Selector Switch

For selecting trigger coupling.

AC: The trigger signal is capacitively coupled to the trigger circuit. The direct current component is eliminated. Use AC coupling for normal waveform measurements.

TV-F: Composite video signal vertical sync pulses are selected out and coupled to the trigger circuit.

TV-L: Composite video signal horizontal sync pulses are selected out and coupled to the trigger circuit.

26 SOURCE Selector Switch

For selecting the trigger signal source.

VERT: The trigger signal source will be selected by the VERT MODE setting. When the VERT MODE Selector Switch is set at CH1, ALT, CHOP, or ADD, the CH1 input signal will become the trigger signal source. When set at CH2, the CH2 input signal will become the trigger signal source.



CH1: The CH1 input signal will become the trigger signal source.

CH2: The CH2 input signal will become the trigger signal source.

LINE: The commercial-use power source voltage waveform will become the trigger signal source.

EXT: The signal being input into the EXT.TRIG jack will become the trigger signal source.

②⑦ **SLOPE Switch (+ / -)**

For selecting the slope polarity of the triggered sweep signal. When the push-button is out (+), triggering will be performed with the trigger source signal rising. When the push-button is pressed in (-), triggering will be performed with the trigger source signal falling.

②⑧ **TRIGGER LEVEL Control**

For adjusting the trigger threshold level. This will determine at what point on the signal waveform slope sweep will commence.

②⑨ **EXT. TRIG Input Jack**

The input terminal for externally generated trigger signals. When the SOURCE switch is set at EXT, signals input through this terminal will become the trigger signal source.

③⑩ **◀▶ POSITION Control**

For adjusting the horizontal position of waveforms displayed on the CRT screen.

③① **SWEEP TIME/DIV Control**

For setting the sweep time. Setting can be carried out over 19 steps between 0.5 μ s/div and 0.5 s/div in 1-2-5 step sequence. [CS-4035 and CS-4026: 20 steps, 0.2 μ s/div to 0.5 s/div]

When the VARIABLE control is set all the way to the right at CAL, sweep rate values will become calibrated.

③② **VARIABLE Control**

Continuous sweep time adjustment can be carried out within the SWEEP TIME/DIV range by this fine control. The sweep time becomes compensated by turning the CAL all the way clockwise.

③③ **× 10 MAG Switch**

Press this switch to magnify the display 10 \times left and right from the center of CRT screen.

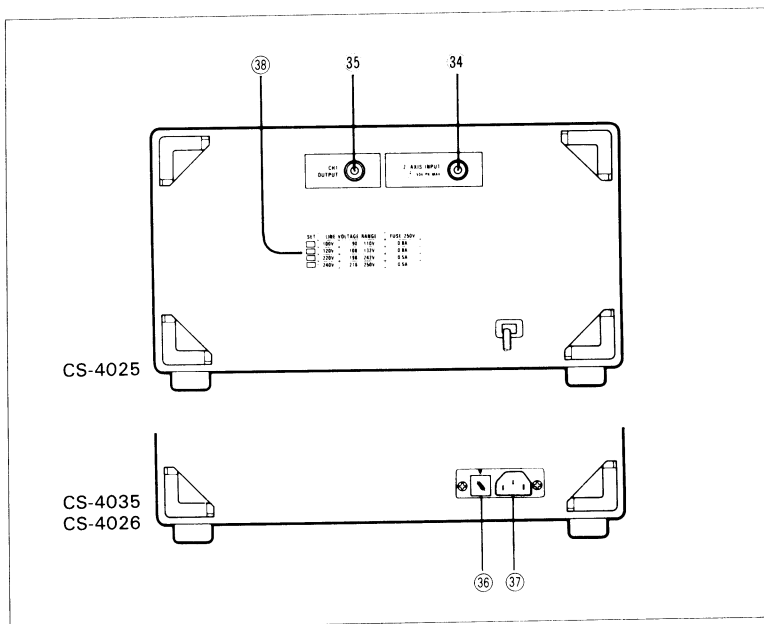

Figure 2. The Rear Panel

REAR PANEL

34 Z. AXIS INPUT Jack

Input jack for intensity modulation of CRT electron beam. Positive voltage decreases intensity. TTL level intensity modulation possible.

35 CH1 OUTPUT Jack

CH1 vertical output terminal. Output occurs at AC coupling. For connecting a counter when measuring frequencies. When using a counter to measure frequencies, there is the possibility that accurate measurements will not be displayed due to noise interference. When this occurs, either set the CH1 VOLTS/DIV to another range, or set the VARIABLE control to a position other than CAL.

36 Fuse Holder, Line voltage selector (Power cord receptacle type only)

Use 0.8 A fuses in 100 and 120 V areas.

Use 0.5 A fuses in 220 and 240 V areas.

Changing the voltage rating should be done strictly according to the directions in the section entitled "FUSE REPLACEMENT AND CHANGING VOLTAGE REQUIREMENTS" and after disconnecting the power cord from the power source inlet.

37 Power Cord Receptacle (Receptacle type only)

A commercial-use power source input connector.

38 Power Source Voltage Rating (Direct power cord type only)

The factory delivered voltage rating. Marked in the SET table.

CHECKING AND ADJUSTMENTS PRIOR TO MEASUREMENT

In order to operate the oscilloscope at its optimum performance level, carry out the following checks and adjustments before doing your measurements. The instructions which follow concerning basic operation techniques and applications assume that the checks and adjustments described here have been completed.

1. Adjust the control panel to the following settings.

MODE	AUTO
COUPLING	AC
SOURCE	VERT
VERT MODE	CH1
(INV:OFF)	
SLOPE	+
TRIGGER LEVEL	12 O'CLOCK
CH1 (Y); CH2 (X)	
◆ POSITION	12 O'CLOCK
VARIABLE	CAL
VOLTS/DIV	5 V/DIV
AC-GND-DC	GND
HORIZONTAL	
◀▶ POSITION	12 O'CLOCK
VARIABLE	CAL
SWEEP TIME/DIV	2 ms/DIV
× 10 MAG	OFF

Next, after checking the power source voltage ratings, switch the POWER control on. The pilot lamp will light up, and a trace line will appear in 10 to 15 seconds. Check to see that rotating the INTENSITY control to the right increases trace brightness, and rotating it to the left decreases brightness.

Then rotate the INTENSITY control all way to left and extinguish the trace line to begin preheating. For the most accurate measurement results, it is necessary to preheat the oscilloscope for about 30 minutes. However, if you intend only to display waveforms, preheating is not necessary.

After preheating, adjust the INTENSITY control so that the trace line is easy to see, and adjust the FOCUS and ASTIG controls to attain the clearest display image possible. Then use the TRACE ROTA control to bring the trace line parallel with the horizontal graduation lines.

3. As soon as the trace line is able to move up and down by rotating the VOLTS/DIV control, adjust the BAL control. Then switch the VERT MODE control to CH2 and adjust the BAL control for Channel 2.

CAUTION: _____

Do not attempt to adjust the BAL control during preheating.

4. Plug the probes (PC-35) into the INPUT jacks of each channel. Set the AC-GND-DC control at DC and the VERT MODE control at CH1. Plug the CH1 probe to the CAL terminal and set the VOLTS/DIV control at 20mV/DIV. Adjust the \blacktriangledown POSITION control so that all of the waveform can be seen. With the waveform in this position, carry out probe compensation adjustment using Figure 3 and the probe Instruction Manual.

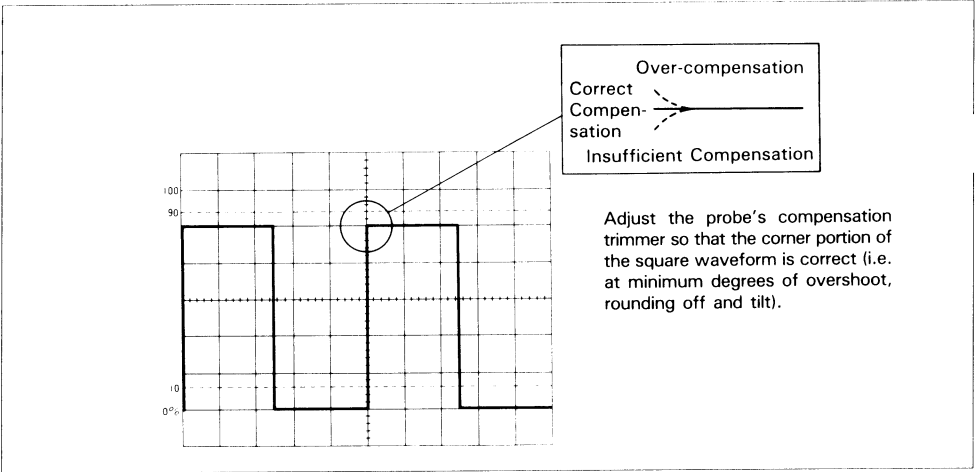

Figure 3. Probe Compensation Adjustment

- Set the VERT MODE control to CH2 and carry out compensation adjustment of the Channel 2 probe. After compensating the channel probes, use the CH1 probe exclusively in Channel 1, and the CH2 probe exclusively in Channel 2. This is necessary because there is a slight capacitance variation between the two channels, and confusing probes will cause changes in compensation adjustments.
5. Return the VERT MODE control to CH1, each channel's AC-GND-DC control to the AC setting, each channel's VOLTS/DIV control to 5 V/DIV, and the \blacktriangledown POSITION and \blacktriangleleft POSITION controls to 12 o'clock.
This is what we refer to as the "initial setting" condition.

OPERATING PROCEDURES

SINGLE TRACE OPERATION

Alternating Current Display

With the oscilloscope in the initial setting condition (refer to Section 5 of CHECKING AND ADJUSTMENTS PRIOR TO MEASUREMENT), display on the CRT screen the signal applied to the CH1 INPUT terminal. Adjust the signal amplitude to an easy to measure size by changing the VOLTS/DIV control setting. The CH1 VARIABLE control may be rotated to change the amplitude in continuous fashion. However, if this is not necessary leave the setting at CAL.

Next, adjust the horizontal SWEEP/TIME control to attain an easy to measure display. Make sure to leave the VARIABLE control setting at CAL.

Whenever the waveform begins to destabilize, it is necessary to use the triggering operation. Rotating the TRIGGER LEVEL left or right will stabilize the waveform. Depending on the type of signal, switching the SLOPE control will also give you clearer displays. These kinds of operations using the TRIGGER LEVEL and SLOPE controls are referred to as **Setting the Trigger Point**. The oscilloscope begins sweeping from pre-set trigger points.

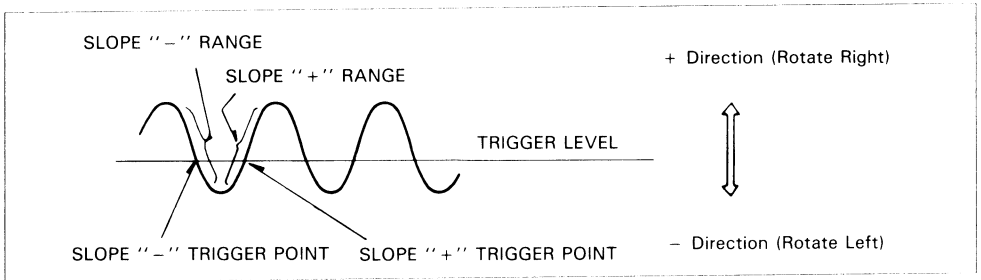

Figure 4. Relationships between Trigger Level and Slope

When inputting low frequency signals or slow occurrence rate signals, switch the MODE control to the NORM setting. Even though the waveform display may disappear from the CRT screen when signal amplitudes are relatively small or the trigger point setting is inappropriate, the NORM setting will allow more stable triggering than can be attained in the AUTO setting.

Composite Video Signal Display

When inputting composite video signals, set the COUPLING control to either TV-F or TV-L. Also switch the SLOPE control in accordance with signal polarity.

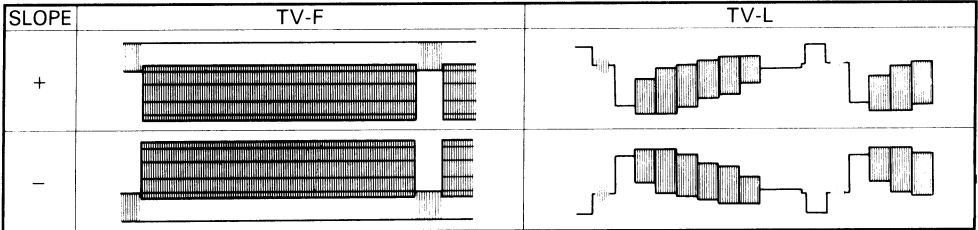

Figure 5. The Relationship between COUPLING and SLOPE

DUAL TRACE OPERATIONS

Switching Vertical Operation Modes

When the VERT MODE control is set at CH2, the CRT screen will display the signal applied to the channel 2 INPUT terminal. The amplitude can be altered using the channel 2 VOLTS/DIV control. The procedures for switching the sweep time and setting the trigger point are the same as for channel 1.

When the VERT MODE control is set at ALT, the CH1 and CH2 signals are displayed one after the other for each sweep.

When the VERT MODE control is set at CHOP, the CH1 and CH2 signals are sub-divided according to time and displayed on the screen.

When the VERT MODE control is set at ADD, CH1 and CH2 signals will be combined (CH1 + CH2) on the CRT display screen. If the INV control is pressed in this condition the differential (CH1 - CH2) of the two channels will be displayed. In order to measure displayed waveforms at the ADD setting, it is necessary that the VOLTS/DIV control settings be the same for both channels.

Switching Trigger Sources

When the VERT MODE control is set at CH1, ALT, CHOP, or ADD and the SOURCE control is set at VERT, the signal source for the trigger becomes channel 1. At this time, if the CH1 signal is too complicated, making the trigger point too difficult, switch the SOURCE control to the CH2 setting. The CH2 signal will be simple enough for a stable trigger point setting. However, when the waveforms of both channels are too complicated, use an external source to set the trigger point.

External Trigger

Set the SOURCE control at EXT and apply a signal to the EXT.TRIG terminal. It is necessary that this signal have a fixed timing relationship to either CH1 or CH2. Also, in order to simplify the trigger point setting process, you should use as simple an external signal as possible.

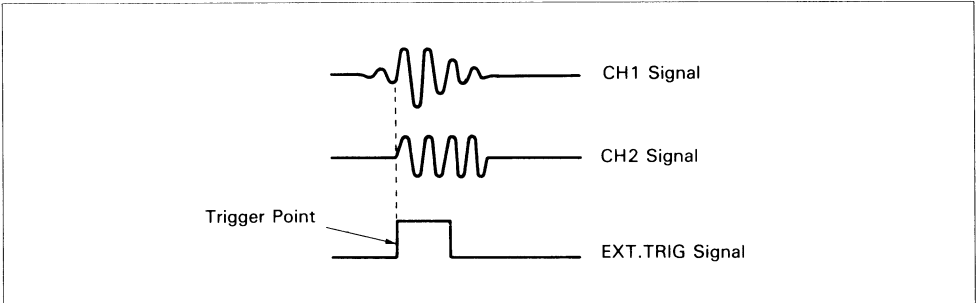

Figure 6. EXT.TRIG

Line Trigger

When the CH1 or CH2 signal is synchronized with a commercial-use power source frequency, setting the SOURCE control at LINE will stabilize the trigger.

SWEEP MAGNIFICATION OPERATION

When carrying out measurements by magnifying a portion of the displayed waveform in terms of time, increasing sweep speed may cause the waveform portion to be measured to disappear from the screen. When this happens, waveform measurement can still be done by magnifying the sweep.

Work the ◀▶ POSITION control to move the waveform portion to be magnified to the middle of the CRT display screen. Then press the × 10MAG control to magnify the waveform 10 times in the horizontal direction.

X-Y OPERATION

The oscilloscope not only has all the functions of a conventional oscilloscope, but may also be operated as an X-Y oscilloscope. With X-Y operation, signals applied to the CH1 INPUT terminal are deflected on the Y-axis, signals applied to the CH2 INPUT terminal are deflected on the X-axis, and Lissajous patterns is depicted. Lissajous patterns makes it possible to find out phase differences between the two signals and find out their relative frequency proportion.

APPLICATIONS

Because both the vertical and horizontal axes of the oscilloscope are calibrated, the oscilloscope is capable of not only displaying waveforms but can also quantitatively measuring voltage or time. When performing these latter measurements, rotate the three VARIABLE controls (CH1 [Y-axis], CH2 [X-axis] and horizontal) all the way in the clockwise direction to the CAL setting. All of the oscilloscope's VARIABLE controls will click when rotated into their CAL settings.

In addition, the oscilloscope comes with PC-35 model probes. These probes should all be plugged into their proper jacks in order to assure a minimum of interference to the signals you want to measure.

Measuring Voltage Between Two Points on a Waveform

Use the following procedures for measuring voltage, etc. between two points or from peak to peak on a waveform.

1. Apply a signal to the INPUT terminal and adjust the VOLTS/DIV and SWEEP TIME/DIV controls. Also reset the trigger point if necessary. Set the AC-GND-DC control at AC.
2. Work the \blacktriangleup POSITION control so that one of the points (A) to be measured falls on one of the horizontal graduation lines, while the other point (B) can still be observed on the CRT display screen.
3. Work the \blacktriangleleft POSITION control so that point B falls on the vertical scale at the center of the CRT screen.
4. Measure the vertical distance between the two points and multiply that value by the VOLTS/DIV setting. When using a PC-35 probe, also multiply the value by the probe's attenuation rate.

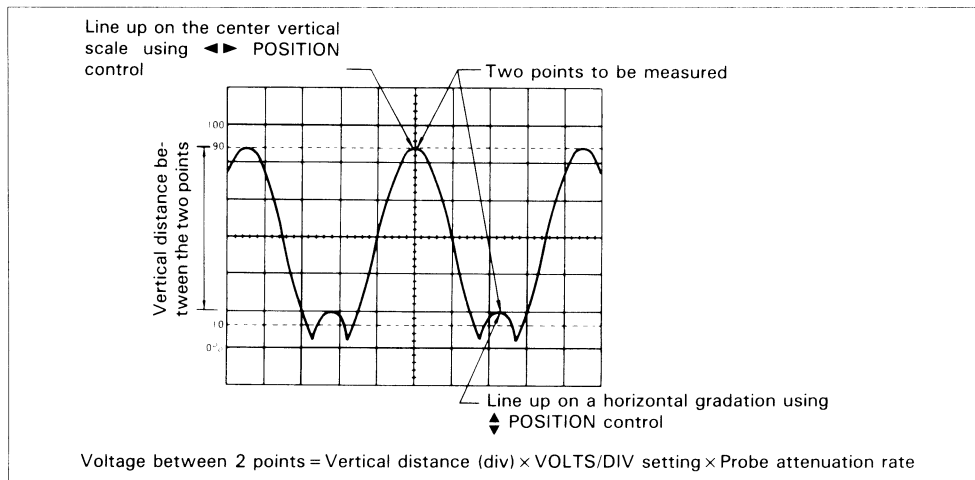

Figure 7. Measuring the Voltage Between Two Points

EXAMPLE:

In Figure 7, the vertical distance between the two points is 4.4 div. If the VOLTS/DIV control is set at 0.2 V/div and a 10:1 PC-35 probe is used, the voltage is calculated as follows:

$$\text{Voltage between 2 points} = 4.4 \text{ (div)} \times 0.2 \text{ (V/div)} \times 10 = 8.8 \text{ V}$$

Common-Mode Rejection

By using the VERT MODE control's ADD setting, unnecessary signal components can be eliminated allowing only desired signal components to be displayed.

1. Apply the whole signal (including its unnecessary components) to the CH1 INPUT terminal. Now apply the component you want eliminated to the CH2 INPUT terminal.
Set the VERT MODE control to ALT or CHOP. Set the SOURCE control at CH2. Set the trigger point at the CH2 signal, and verify that CH2 contains the unnecessary component of CH1.
3. Press the INV control, and verify that the CH2 signal represents the unnecessary component in reverse polarity. When the VERT MODE control is set at ADD under these conditions, only the necessary signal components will be displayed on the CRT screen.

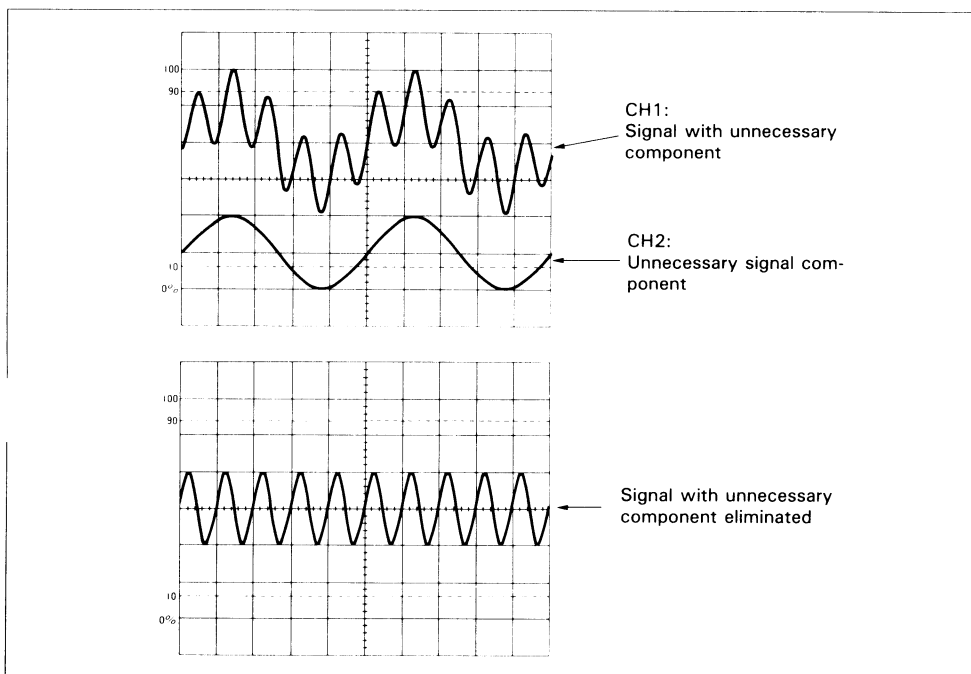

Figure 8. Common-Mode Rejection

Note:

Elimination capabilities vary with the size of the unnecessary component. In order to attain the best results, display the CH2 signal with a slightly higher VOLTS/DIV setting. After pressing the INV control, and activating the ADD function, adjust the VARIABLE control of CH2 to get a good waveform.

Also, after pressing the INV control and switching to the ADD setting, the displayed waveform may move up or down. Move it back to the display position using the \blacktriangle POSITION control for CH2.

Measuring Direct Current (DC) Voltage

The oscilloscope's vertical amplification is provided by a direct current amplifier circuit characterized by excellent stability. By switching the AC-GND-DC control to the DC setting direct current voltage can be measured.

1. Apply the signal to the INPUT terminal. Work the VOLTS/DIV and SWEEP TIME/DIV controls to display the waveform at an easy to see size. Also adjust the TRIGGER LEVEL control if necessary.
2. Set the MODE control to AUTO, and then set the AC- GND-DC control to GND. The trace will be displayed on the CRT screen. This trace will become the ground potential. Work the \blacktriangle POSITION control to bring the trace in line with one of the horizontal graduation lines. Usually signals with positive potentials are lined up at the 0% graduation and signals of negative potential at the 100% graduation. Once lined up, the trace's position will become the reference potential, so do not touch the \blacktriangle POSITION control during the measurement process.
3. Set the AC-GND-DC control at DC. The signal will be displayed on the CRT screen with the direct current component intact. If in this case either the VOLT/DIV or reference potential setting is inappropriate, the waveform may disappear from the display screen. Make sure to check these settings.
4. Measure the potential using the procedure for measuring the voltage between two points. The potential sign will be plus if above the reference and minus if below the reference.

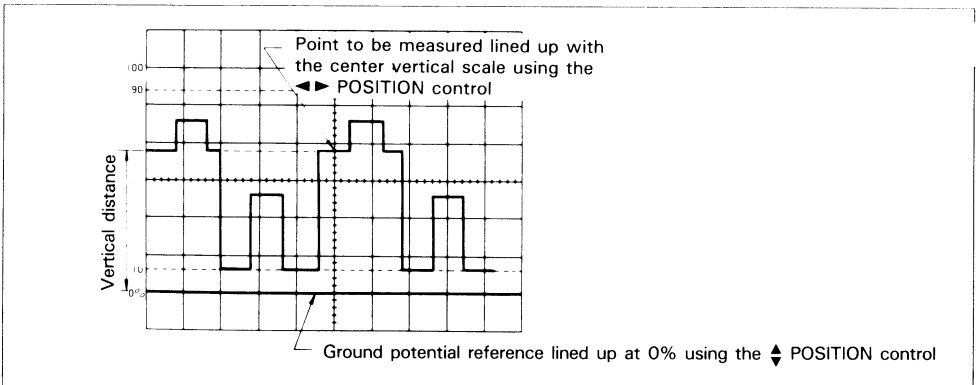

Figure 9. DC Voltage Measurement

5. There is a REF button on the PC-35 probe. Press this button to display the ground potential on the CRT screen. This eliminates the bother of having to set the AC-GND-DC control to GND.
6. If there is only one signal to be measured, apply it to CH1, and work the CH2 POSITION control so that CH2 displays the ground potential. If the VERT MODE control is set at either ALT or CHOP after this adjustment is made, you will be certain of the ground potential throughout the procedure. However, make certain that the ground potentials of both channels are always the same.

Measuring Signals with Low Frequency Components

When the oscilloscope's AC-GND-DC control is set at AC, there is a chance that errors may occur in the voltage measurement. This inaccuracy is caused by low range cut-off frequencies. At AC, the most accurate frequency measurements are realized above the 40 to 50 Hz range. Therefore, when measuring frequencies below this range switch the AC-GND-DC control to the DC setting.

If, however, you are using a PC-35 probe, accurate measurements of frequencies as low as 4 to 5 Hz can be realized at AC.

Measuring Signals with High Frequency Components

Always use a probe when measuring pulses or signals of a few hundred kHz or above. This is because distortion will occur in the waveform's high frequency component due to the use of long leads. This makes it difficult to conduct accurate waveforms. This is also true for probes with long ground leads, so keep them as short as possible. In addition, make sure to connect the ground lead clip to the ground potential lying closest to the signal to be measured.

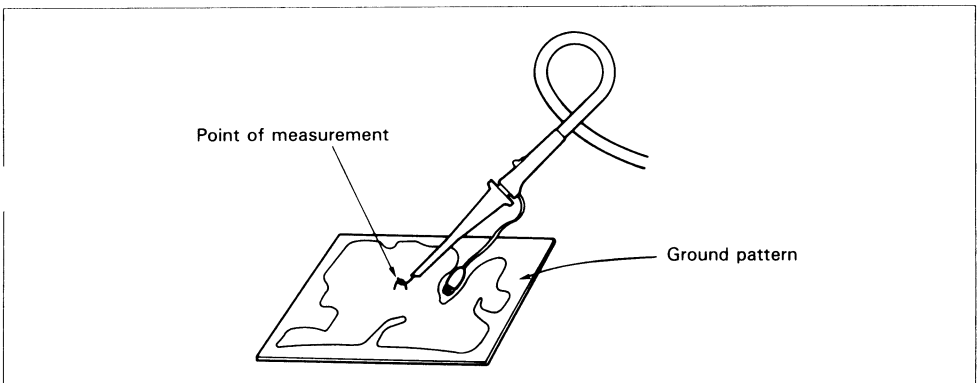

Figure 10. Measuring Signals with High Frequency Components

Measuring Time Between Two Points

When measuring time between two points, measurements can be determined from SWEEP TIME/DIV and horizontal distance.

1. Display the waveform by adjusting each control. Set all the VARIABLE controls to the CAL position.
2. Work the ◀▶ POSITION control to bring one point to be measured in line with a vertical graduation line. Then work the ⬇ POSITION control to bring the other point to be measured in line with the horizontal scale in the middle of the CRT display screen.
3. Measure the horizontal distance between the two points. Multiply this value by the SWEEP TIME/DIV setting value. If the $\times 10$ MAG function has been activated, multiply the value by 1/10.

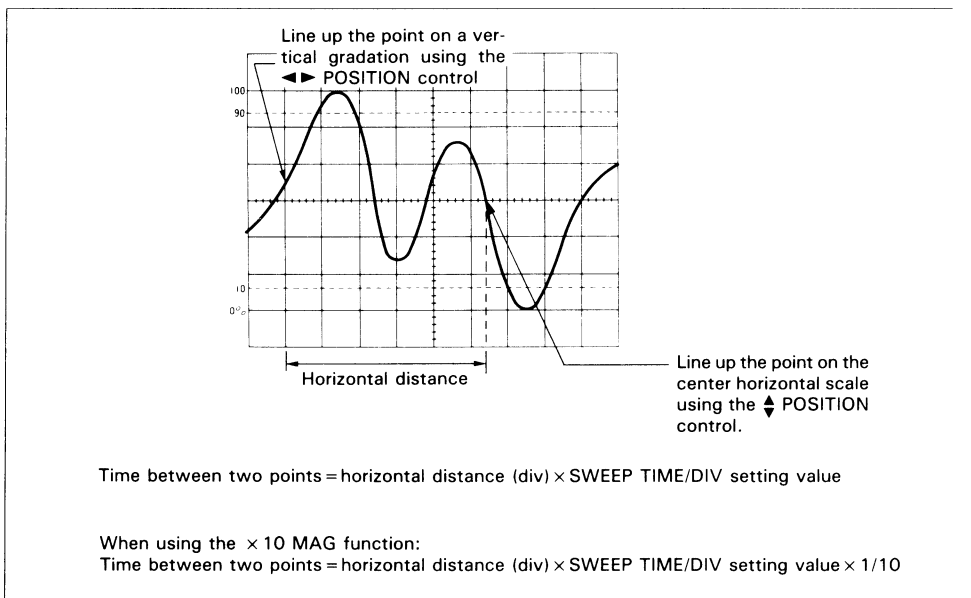

Figure 11. Time Measurement

EXAMPLE:

In the case of Figure 11, the horizontal distance between the two points is 5.4 div. If the SWEEP TIME/DIV setting value is 0.2 ms/div, the time between the two points may be calculated as follows.

$$\text{Time between two points} = 5.4 \text{ div} \times 0.2 \text{ ms/div} = 1.08 \text{ ms}$$

If the $\times 10$ MAG function is in use:

$$\begin{aligned} \text{Time between two points} &= 5.4 \text{ div} \times 0.2 \text{ ms/div} \times 1/10 = 0.108 \text{ ms} \\ &= 108 \mu\text{s} \end{aligned}$$

Measuring Frequencies

Since the frequency is found as a reciprocal of a period, measure the time (period) of one cycle and calculate its reciprocal value.

1. Measure the time of one cycle.
2. Calculate the reciprocal value of the period found.

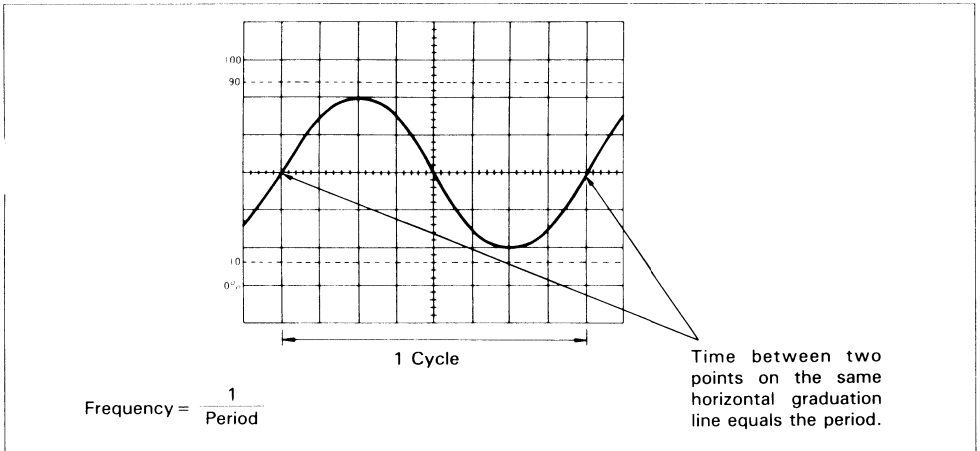

Figure 12. Measuring Frequency

EXAMPLE:

In the case of Figure 12, the period found comes to $40 \mu\text{s}$. The frequency is calculated as follows:

$$\text{Frequency} = \frac{1}{40 \times 10^{-6}} = 25 \times 10^3 = 25 \text{ kHz}$$

Measuring Pulse Rise and Fall Times

Rise (fall) time is found by measuring the time between 10% and 90% of the peak value. For this purpose the oscilloscope has been equipped with additional graduations at 10% and 90%.

1. Apply the signal. Adjust the VOLTS/DIV and VARIABLE control so that the amplitude is 6 div [5 div for CS-4035 and CS-4026]. Set the horizontal VARIABLE control at CAL.
2. Rotate the SWEEP TIME/DIV control as fast a setting as possible until the the section showing rise (fall) becomes visible. Press the $\times 10$ MAG control if necessary.
3. Work the \blacktriangle POSITION control to move the waveform between 0% and 100%. Then work the $\blacktriangleleft \blacktriangleright$ POSITION control to move the starting point of rise to the 10% graduation with a vertical graduation line. Measure the horizontal distance to the 90% graduation. The time is found from this distance measurement.

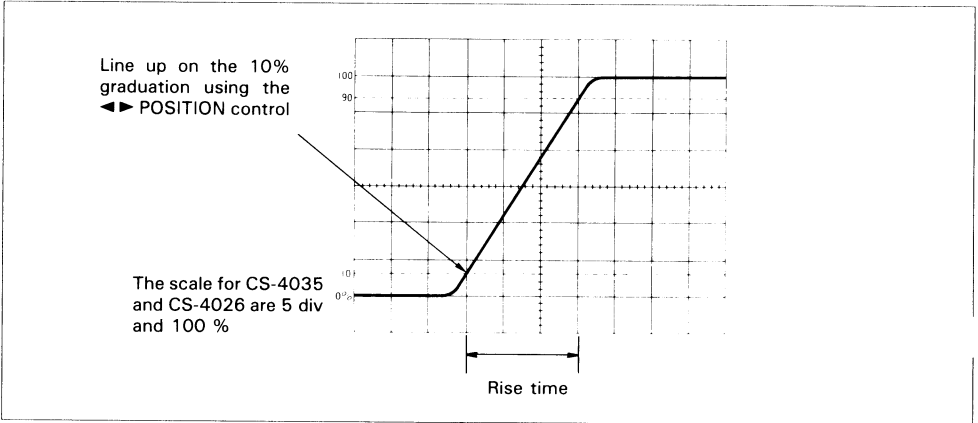

Figure 13. Measuring Rise Time

Note:

When measuring high speed rise (fall) times, you must use the following correction formula to calculate the true rise time, t_o , since there is rise time inherent to the oscilloscope itself.

$$t_o = \sqrt{t_m^2 - t_r^2}$$

where t_m is the actually measured value, and t_r is the oscilloscope's inherent rise time.

Since the rise time of the CS-4025 and CS-4026 itself is 17.5 ns [8.75 ns for CS-4035], when, for example, the value actually measured is 50 ns, the true rise time comes to:

(Case of CS-4025 and CS-4026)

(Case of CS-4035)

$$t_o = \sqrt{50^2 - 17.5^2} = 46.8 \text{ ns}$$

$$t_o = \sqrt{50^2 - 8.75^2} = 49.2 \text{ ns}$$

However, this correction factor is not significant when the actually measured value, t_m , is above 200 ns.

Measuring Phase Differences

When carrying out dual trace operations, phase differences can be measured between, for example, two sine wave signals of identical frequency.

1. Apply the two signals to their respective INPUT terminals. Adjust the VOLTS/DIV and VARIABLE controls so that the two signals are at identical amplitude.
2. Adjust the SWEEP TIME/DIV and VARIABLE controls so that one period of the waveforms is 8 div.
3. Work the $\blacktriangleleft\blacktriangleright$ POSITION controls of both channels to bring the waveforms to the center of the CRT display screen.
4. Measure the horizontal distance between corresponding points on the two signals. There is a phase difference of 45 degrees for every 1 division of horizontal distance.

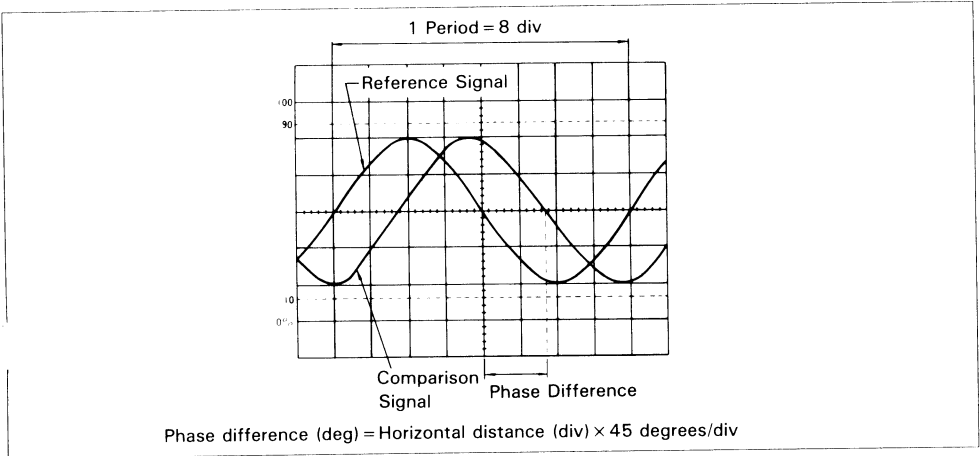

Figure 14. Measuring Phase Difference

Displaying Lissajous Patterns

When operating the oscilloscope in the X-Y mode, Lissajous patterns can be displayed. With Lissajous patterns it is possible to find even the slightest phase difference or signal distortion and also find relative frequency proportions.

1. Apply the signal to be measured to the CH1 (Y-axis) INPUT terminal and a reference signal to the CH2 (X-axis) INPUT terminal.
2. Set the MODE control to X-Y.
3. Adjust the VOLT/DIV and VARIABLE controls of both channels to attain an acceptable display.

Phase difference can be measured with Lissajous patterns in the following manner.

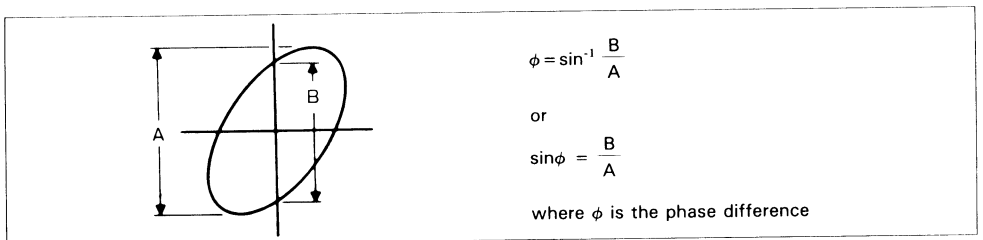

Figure 15. Measuring Phase Difference with Lissajous Patterns

The following represent Lissajous patterns indicating the presence of signal distortion or phase difference.







		
Amplitude distortion, no phase discrepancy	No amplitude distortion, no phase discrepancy	No amplitude distortion, 180° phase discrepancy
		
Amplitude distortion, phase discrepancy	No amplitude distortion, 90° phase discrepancy	No amplitude distortion, phase discrepancy

Figure 16. Representative Lissajous Patterns

The following represent Lissajous patterns when input frequency proportions are altered.















0°	45°	90°	135°	180°	Frequency Proportion (CH1[Y]:CH2[X])
					1 : 1
					1 : 2
					1 : 3

Figure 17. Lissajous Patterns When Frequency Proportions Are Altered

Note: _____
 In the phase difference measuring process using Lissajous patterns, the value will not change even if the VARIABLE controls are rotated.
 Therefore carry out the measurement at the clearest display possible.

FUSE REPLACEMENT, CHANGING VOLTAGE REQUIREMENTS

CAUTION:

Before performing the following procedures, always unplug the power cord.

FUSE REPLACEMENT

Direct Power Cord Models (CS-4025)

There is no external access to the fuse in units equipped with direct power cords. For example, if the power is switched on and the pilot fails to light up, the most likely reason is that the fuse has blown. When this happens contact the store where you purchased your oscilloscope or a nearby dealer.

Power Cord Receptacle Models (CS-4035, CS-4026 and CS-4025)

There is external access to the fuse in models equipped with power cord receptacles. Whenever there is a fuse failure, first investigate and correct the cause of the failure. Then follow the procedures shown in Figure 18 to replace the fuse. If you suspect that the cause of fuse failure can be attributed to a malfunctioning of the oscilloscope itself, contact the store where you purchased it or a nearby dealer. In this case, leave the blown fuse intact in the main unit.

CHANGING VOLTAGE REQUIREMENTS

Voltage requirements cannot be changed in models equipped with direct power cords. If you need to change voltage requirements, contact the store where you purchased your oscilloscope or a nearby dealer.

For models equipped with power cord receptacles, change the voltage requirement according to the procedure shown in Figure 18. The value lined up with the ▼ mark is the voltage requirement that the main unit will respond to. Make sure to check that the main unit's fuse is of a type that corresponds to the altered voltage requirement.

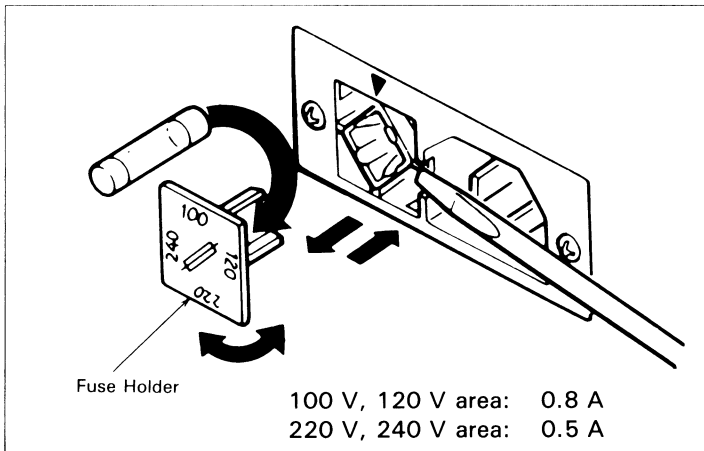





Figure 18. Fuse Replacement and Changing Voltage Requirements

SPECIFICATIONS

	CS-4035	CS-4026	CS-4025
CRT:			
Type:	Rectangular with internal graticule		
Acceleration Voltage:	Approx. 12 kV	Approx. 2 kV	
Display Area:	8 × 10 div (1 div = 10 mm)		
VERTICAL AXIS (CH1 and CH2):			
Sensitivity:	1 mV, 2 mV/div ± 5%, 5 mV/div ~ 5 V ± 3%		
Attenuator:	1-2-5 step, 12 range with fine adjustment		
Input Impedance:	1 MΩ ± 2%, Approx. 28 pF		
Frequency Response 5 mV/div ~ 5 V/div:	DC: DC ~ 40 MHz within - 3 dB AC: 10 Hz ~ 40 MHz within - 3 dB	DC: DC ~ 20 MHz within - 3 dB AC: 10 Hz ~ 20 MHz within - 3dB	
1 mV/div, 2 mV/div:	DC: DC ~ 5 MHz within - 3 dB AC: 10 Hz ~ 5 MHz within - 3 dB	DC: DC ~ 5 MHz within - 3 dB AC: 10 Hz ~ 5 MHz within - 3 dB	
Rise Time:	8.75 ns maximum	17.5 ns maximum	
	70 ns maximum (5 MHz)		
Crosstalk:	- 40 dB maximum		
Operating Modes:	CH1: CH1 single trace CH2: CH2 single trace ALT: Alternating display of two signal CHOP: Chopped display of two signal ADD: Display of combined CH1 + CH2 waveforms		
CHOP Frequency:	Approx. 250 kHz		
Channel Polarity:	Normal or inverted, channel 2 only inverted		
Non-distorted Maximum Amplitude:	More than 8 div (DC to 40 MHz)	More than 8 div (DC to 20 MHz)	
 Maximum Input Voltage:	500 V _{p-p} or 250 V (DC + AC _{peak})		
HORIZONTAL AXIS:			
Sensitivity:	Same as vertical axis (CH2)		
Input Impedance:	Same as vertical axis (CH2)		
Frequency Response:	DC: DC ~ 500 kHz within - 3 dB AC: 10 Hz ~ 500 kHz within - 3 dB		
X-Y Phase Difference:	3° or less at 50 kHz		
Operating Modes:	X-Y operation is selectable with MODE switch CH1: Y-axis CH2: X-axis		
 Maximum Input Voltage:	Same as vertical axis (CH2)		

	CS-4035	CS-4026	CS-4025
SWEEP SYSTEM:			
Sweep Modes:	NORM: Triggered sweep AUTO: Auto free run with no signal input		
Sweep Time:	0.2 μ s/div ~ 0.5 s/div, \pm 3% 1-2-5 step, 19 range with fine adjustment	0.5 μ s/div ~ 0.5 s/div \pm 3%, 1-2-5 step, 19 range with fine adjustment	
Sweep Expansion:	10 \times magnification, \pm 5%		
Linearity:	\pm 3% (\pm 5% at \times 10 MAG)		

TRIGGERING:	
Trigger Signal Source:	VERT: Input signal selection with VERT MODE control CH1: CH1 input signal CH2: CH2 input signal LINE: Commercial-use power source EXT: Signal input through EXT.TRIG terminal
External Trigger:	
Input impedance:	1 M Ω , Approx. 35 pF
 Maximum Input Voltage:	100 V _{P-P} or 50 V (DC + AC _{peak})
Trigger Coupling Modes:	AC: Trigger is capacitively coupled; dc component is blocked. TV-F: Vertical sync pulses of a composite video signal are selected for triggering. TV-L: Horizontal sync pulses of a composite video signal are selected for triggering.

Trigger Sensitivity:

CS-4035:

MODE	COUPLING	SIGNAL FREQ.	SOURCE	
			VERT CH1, CH2	EXT
NORM	AC	10 Hz ~ 20 MHz	1.5 div	0.25 V _{P-P}
		20 MHz ~ 40 MHz	2.0 div	0.3 V _{P-P}
	TV-F, TV-L	Composite Video Signal	1.0 div	0.2 V _{P-P}
AUTO	Same as above specs at 50 Hz or above			

CS-4026, CS-4025:

MODE	COUPLING	SIGNAL FREQ.	SOURCE	
			VERT CH1, CH2	EXT
NORM	AC	10 Hz ~ 10 MHz	1.0 div	0.2 V _{P-P}
		10 MHz ~ 20 MHz	1.5 div	0.3 V _{P-P}
	TV-F, TV-L	Composite Video Signal	1.0 div	0.2 V _{P-P}
AUTO	Same as above specs at 50 Hz or above			

	CS-4035	CS-4026	CS-4025
CALIBRATED SIGNALS:			
Waveform:	Positive square wave		
Voltage:	1 V _{P-P} , ± 3%		
Frequency:	Approx. 1 kHz	100 Hz or 120 Hz (Twice the frequency of a commercial-use power source)	
INTENSITY MODULATION:			
Sensitivity:	TTL level, positive voltage decreases brightness		
Input Impedance:	Approx. 5 kΩ		
Usable Frequency Range:	DC ~ 3.5 MHz		
⚠ Maximum Input Voltage:	100 V _{P-P} or 50 V (DC + AC _{peak})		
CH1 SIGNAL OUTPUT:			
Output Voltage:	Approx. 50 mV/div (50 Ω termination)		
Output Impedance:	Approx. 50 Ω		
Frequency Response:	10 Hz ~ 20 MHz within ± 3 dB (50 Ω termination)	100Hz ~ 10MHz within ± 3 dB (50 Ω termination)	
TRACE ROTATION:			
Adjustment:	Adjustable from front panel		
OTHERS:			
DIMENSIONS (W × H × D)	290 (290) × 150 (170) × 380 (440) mm () dimentions include protrusion from basic outline dimentions		
WEIGHT	Approx. 7 kg	Approx. 6.8 kg	
ENVIRONMENTAL			
Within specifications:	10 to 35°C, 85% max. relative humidity		
Full operation:	0 to 40°C, 85% max. relative humidity		
LINE VOLTAGE/FREQUENCY	100/120/220 VAC ± 10%, 216 to 250 VAC, 50/60 Hz		
POWER CONSUMPTION	Approx. 30 W	Approx. 29 W	
ACCESSORIES:			
Probe:	PC-35 × 2	Attenuation Input impedance	1/10 10 MΩ ± 2% 19.5 pF ± 10%
Instruction manual:		1	
Power Cord:	1	1	1 (Power cord receptacle type only.)
Replacement Fuse:	2	2	2 (Power cord receptacle type only.)

Note: _____

The above specifications are subject to change without notice.

OPTIONAL EQUIPMENT

The oscilloscope offers an optional accessory bag. This bag attaches to the right side of the oscilloscope housing and provides a storage space for two probes and the instruction manual.

How to Attach the Accessory Bag (MC-78)

1. Separate the accessory bag itself from the attached mounting plate.
 2. Line up the four holes on the right side (from the front) of the oscilloscope case with the corresponding four holes in the mounting plate. Fix the the mounting plate to the oscilloscope case using the four nylon rivets and washers provided. Be sure that the mounting plate is in the vertical position as shown in Figure 19. Riveting is done by first inserting the grommet into the holes and then the plunger. (When removing just pry the plunger out with a straight edge (–) screwdriver.
- Next attach the bag to the mounting plate with the hooks provided.

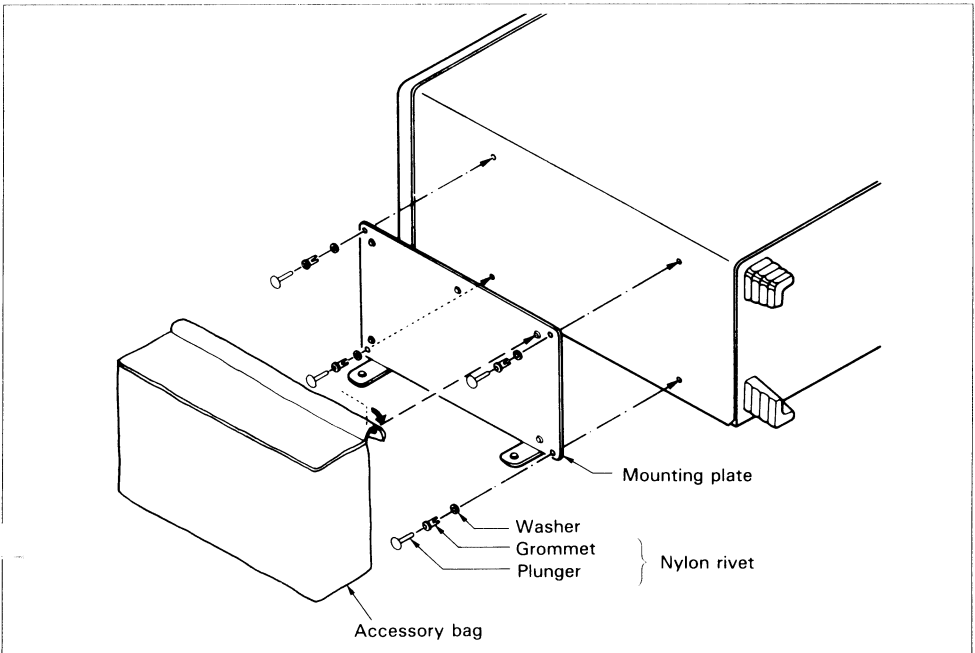

Figure 19. Attaching the Accessory Bag

A product of
KENWOOD CORPORATION
2-5, 1-chome, Shibuya, Shibuya-ku, Tokyo 150, Japan
